

DUSJHJØRNE

Art nr. 2002

80 x 80 x 190cm

70 x 90 x 190cm

90 x 90 x 190cm

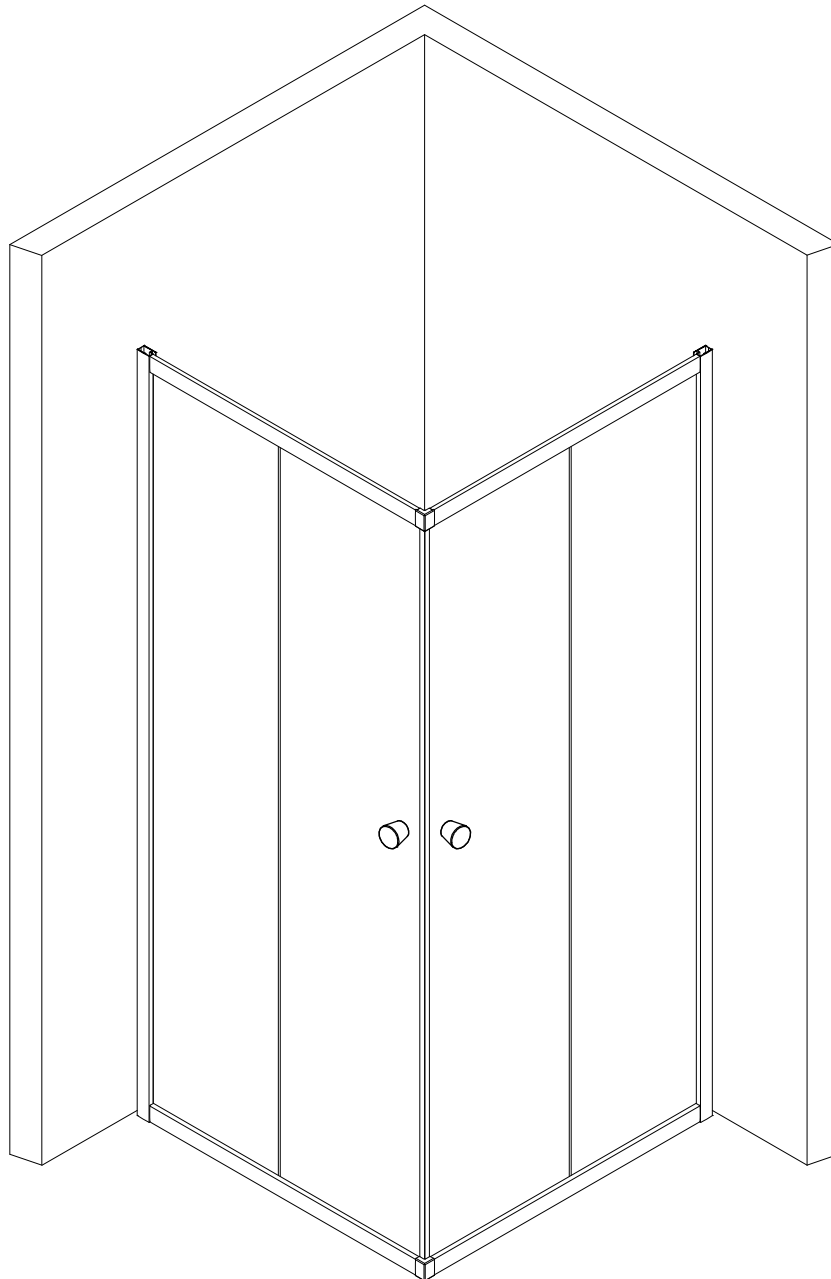

www.sanipro.no

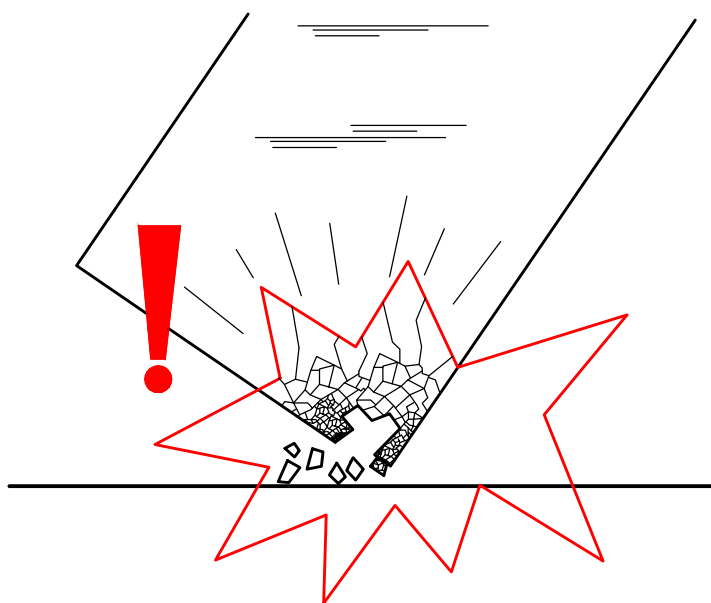
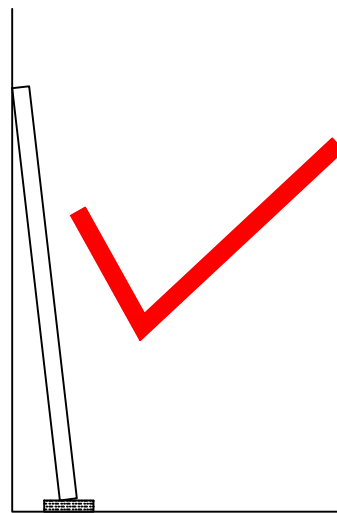
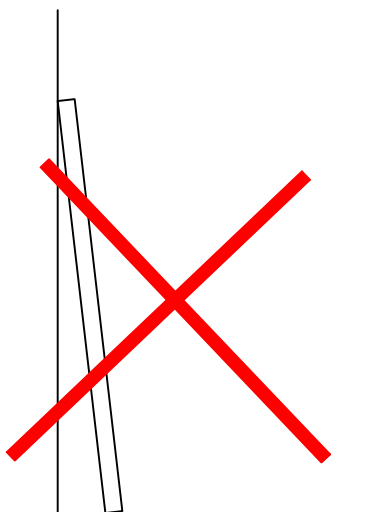

NB! Sett aldri glasset rett på gulvet, legg under papp eller annet.

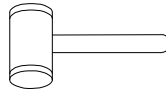
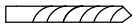
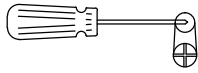
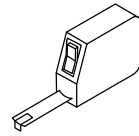
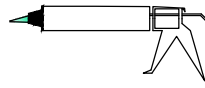
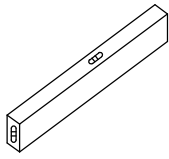

Ø6

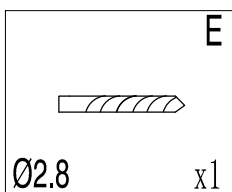
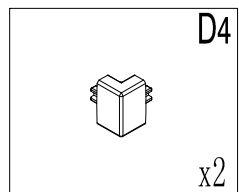
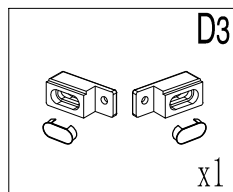
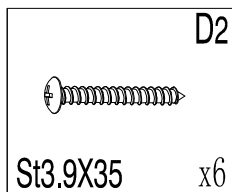
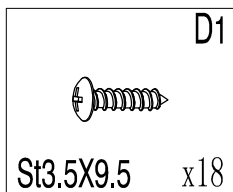
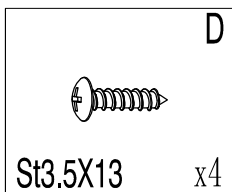
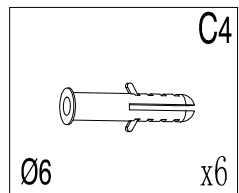
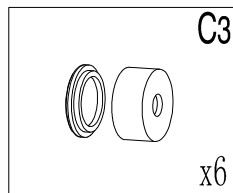
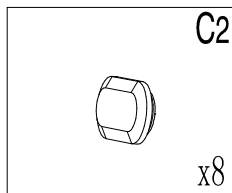
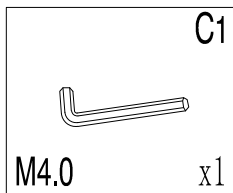
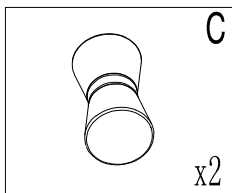
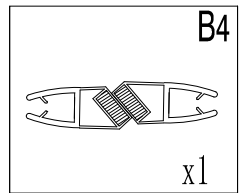
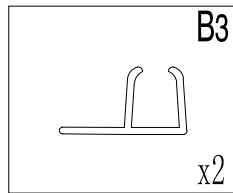
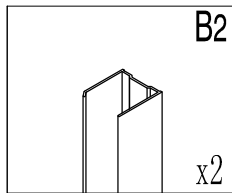
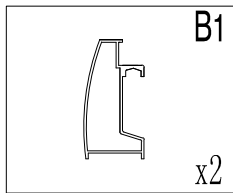
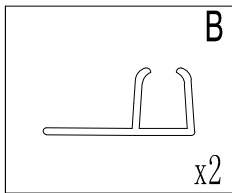
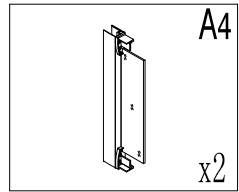
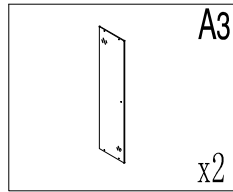
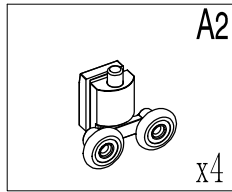
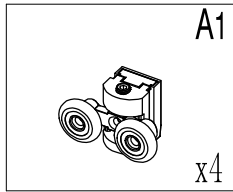
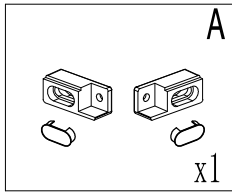

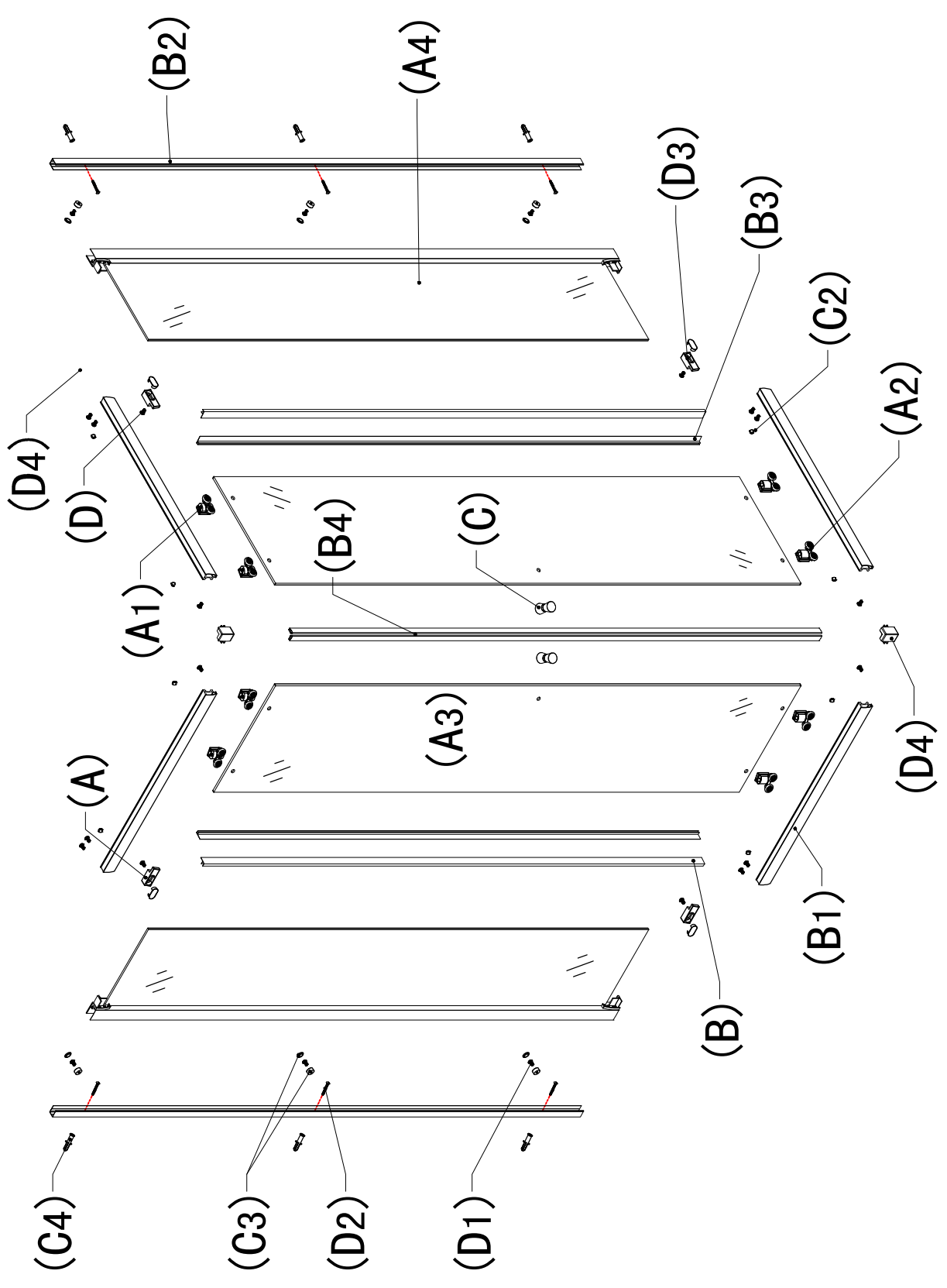

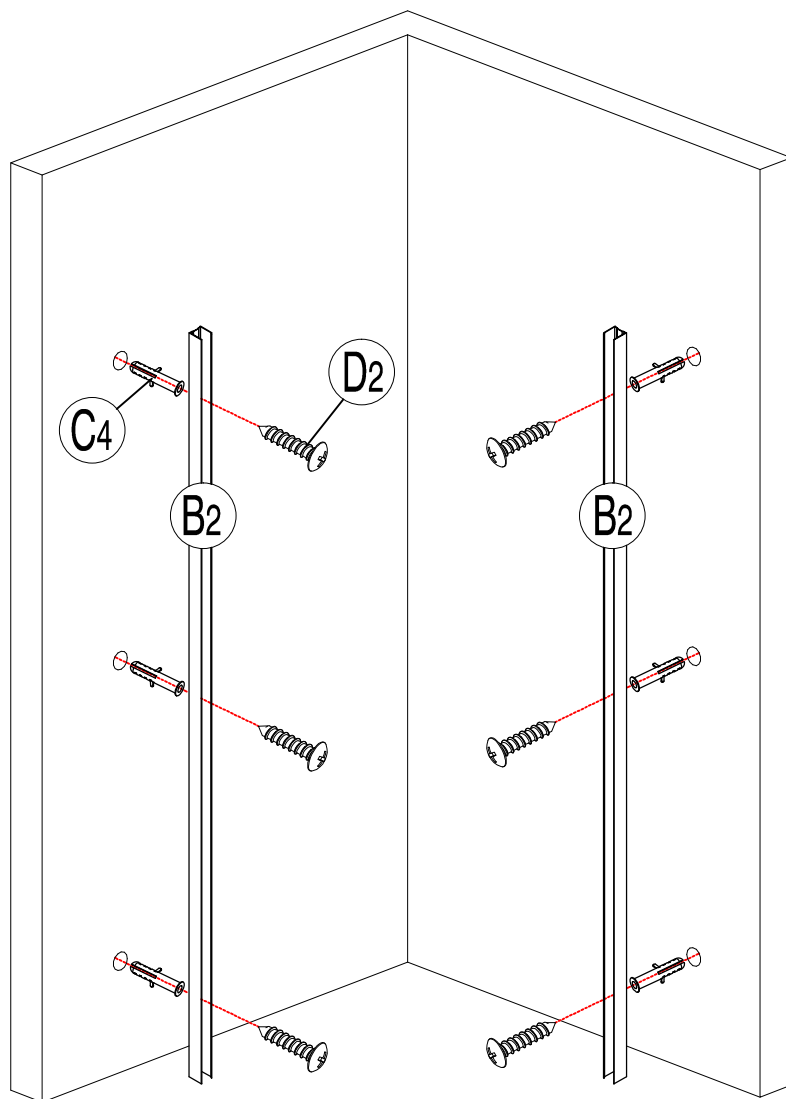

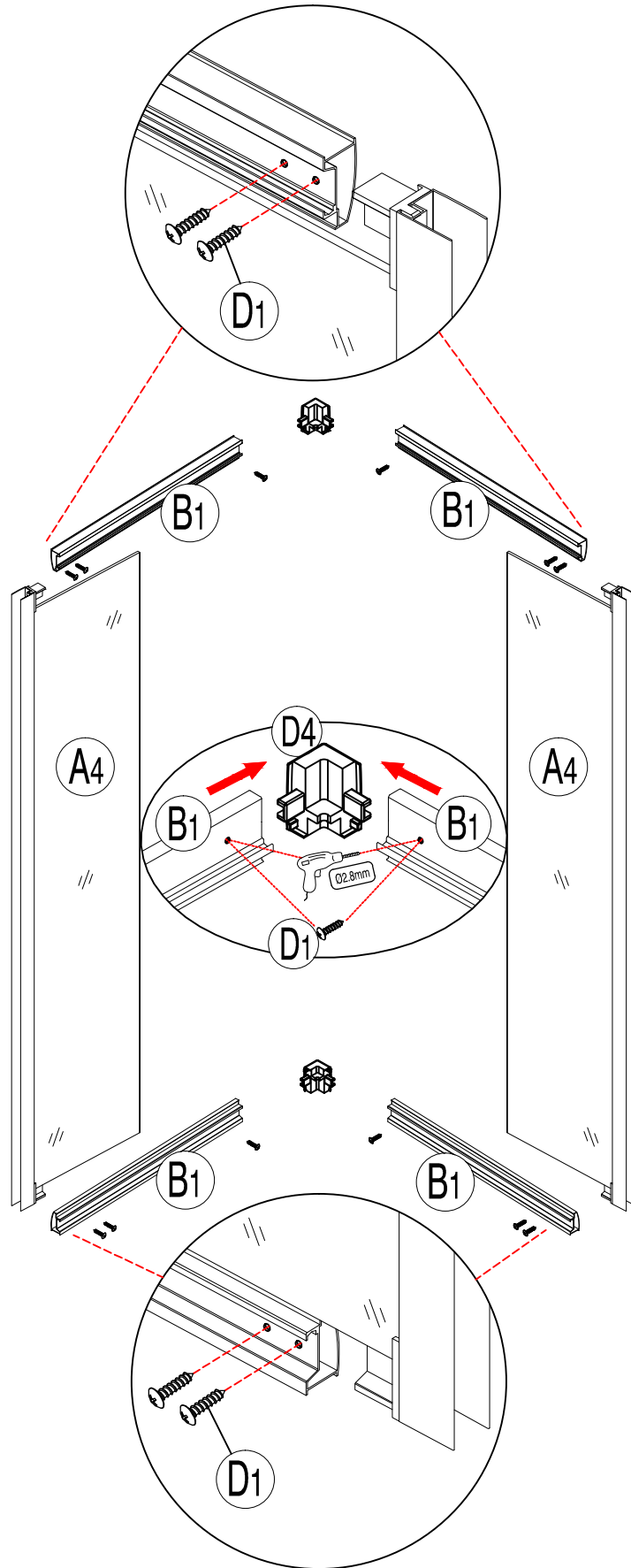

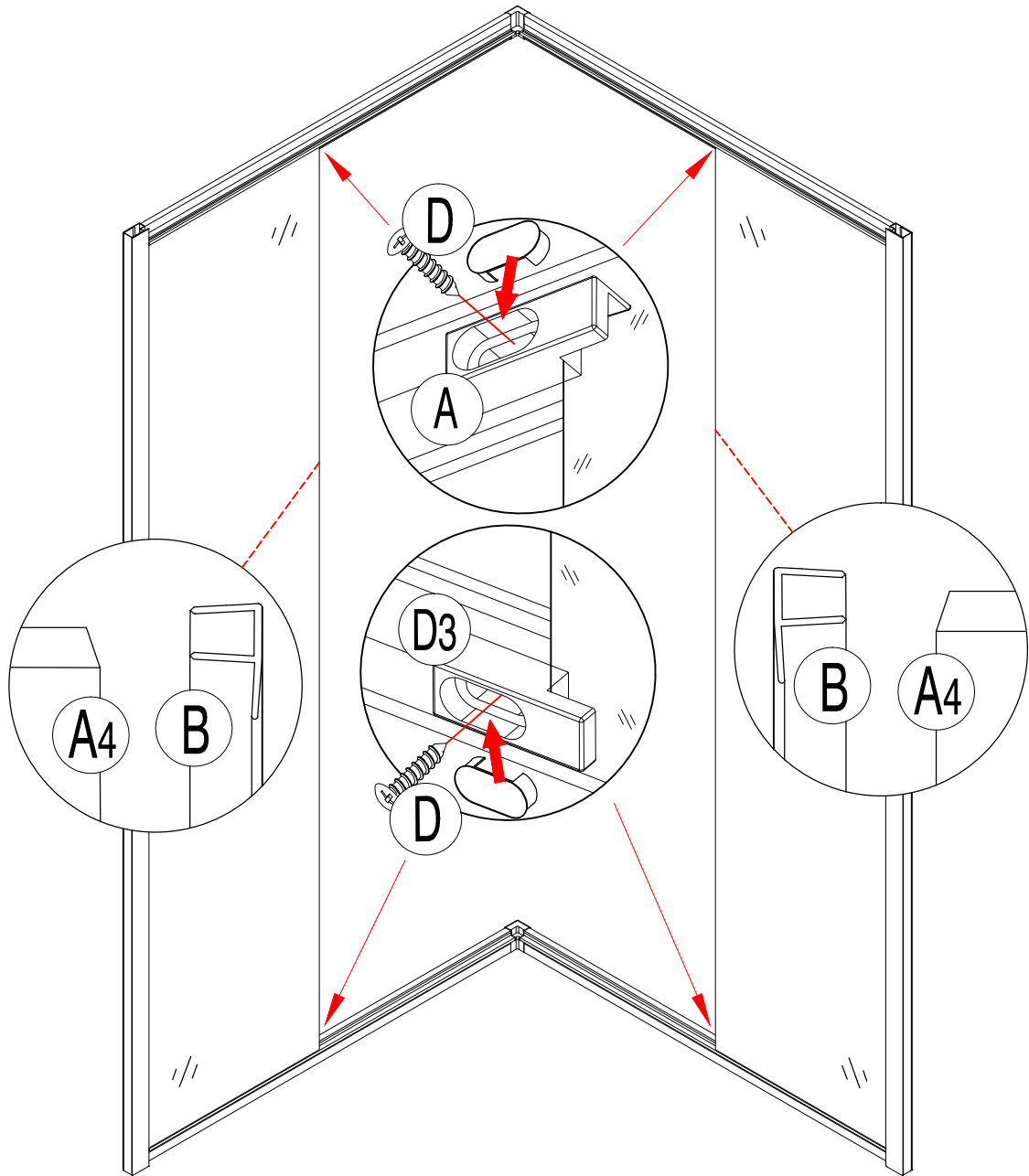

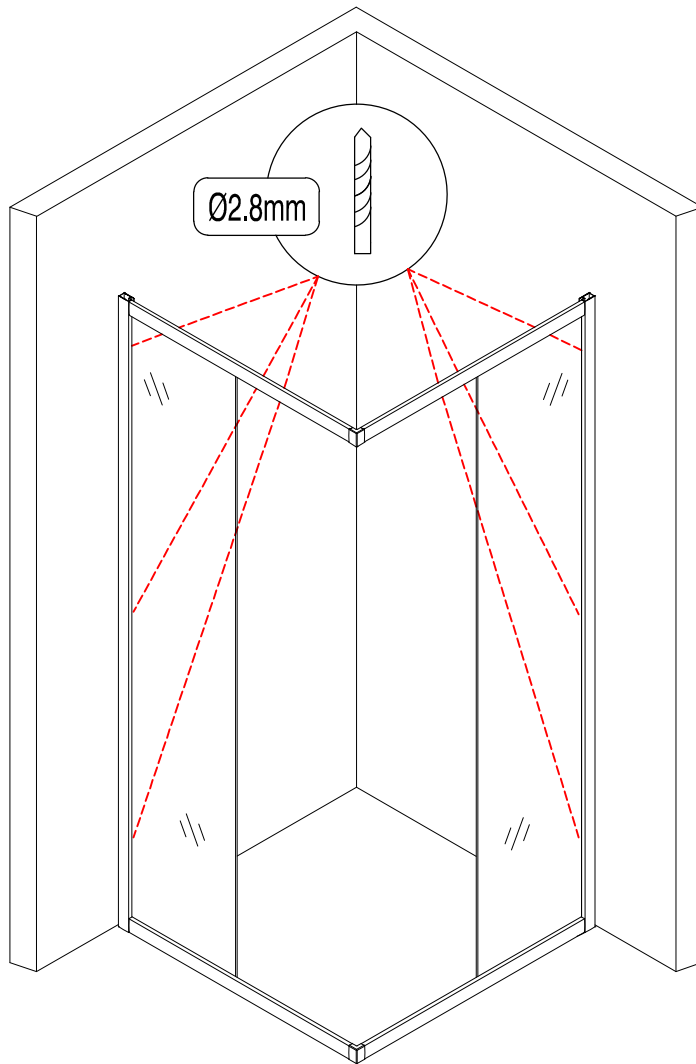
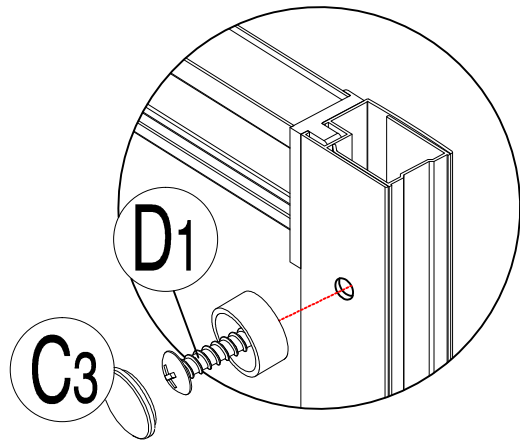
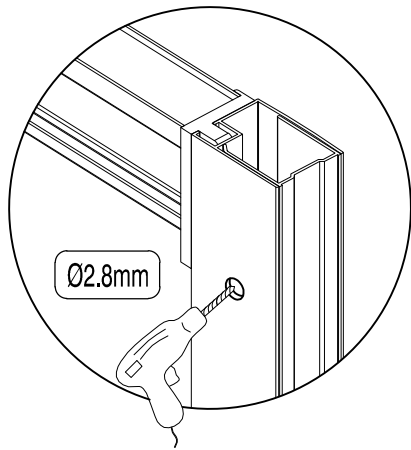

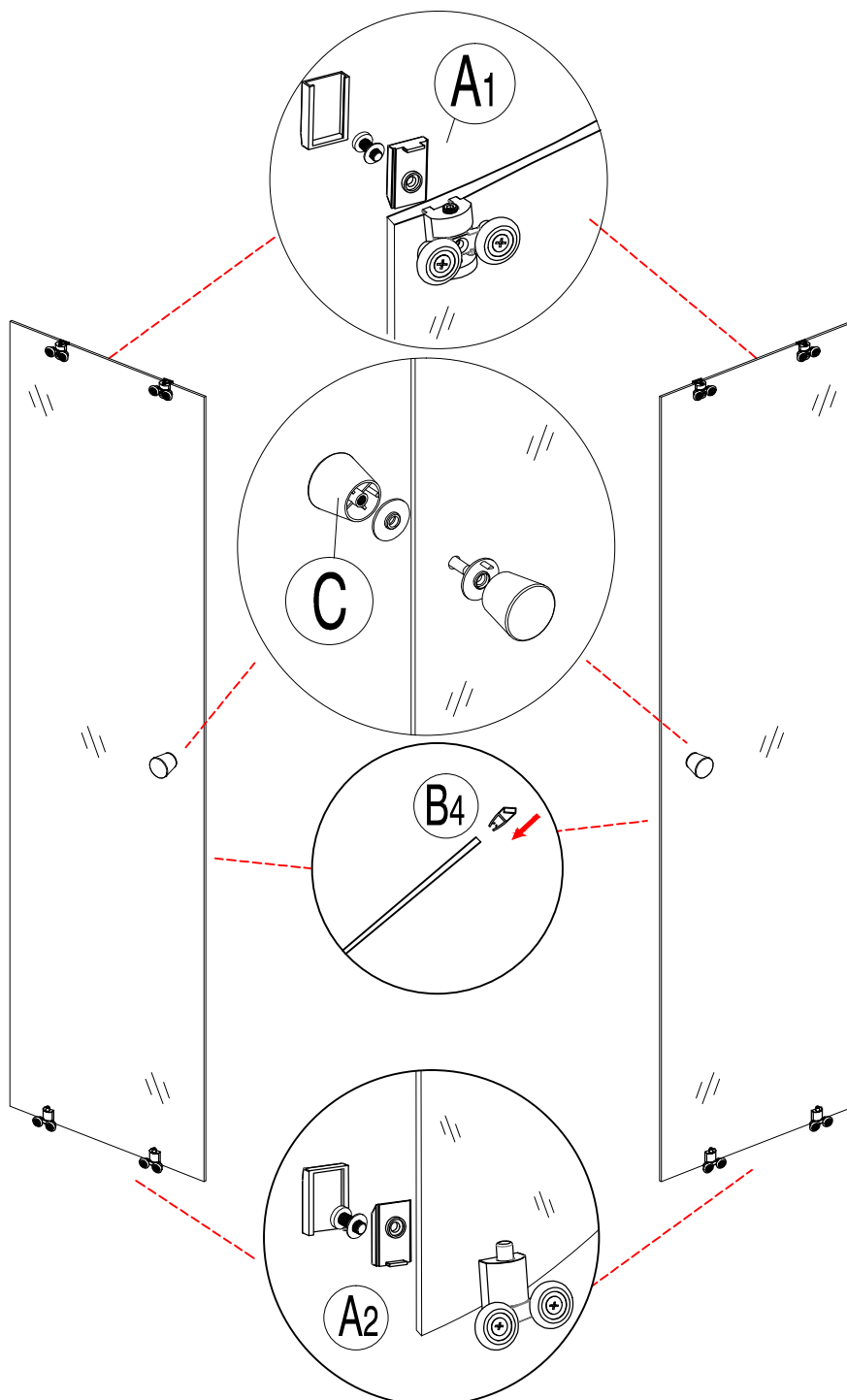

Husk: Trinsehjulene nede på glasset, skal ha fjærbelastningsutløser, slik at du lett Kan løsne døren for enkel renhold.

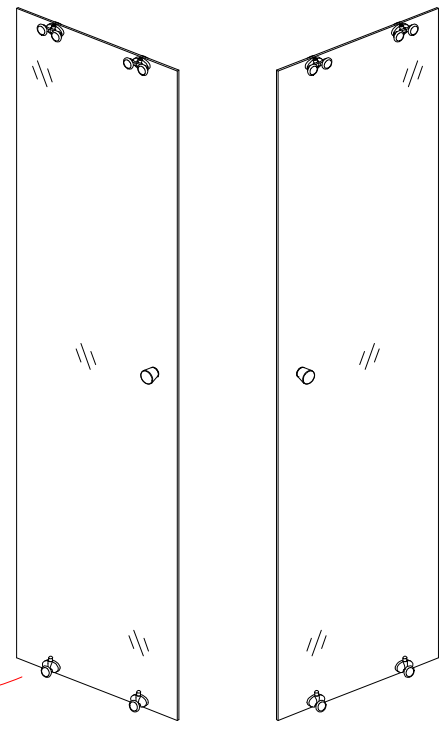
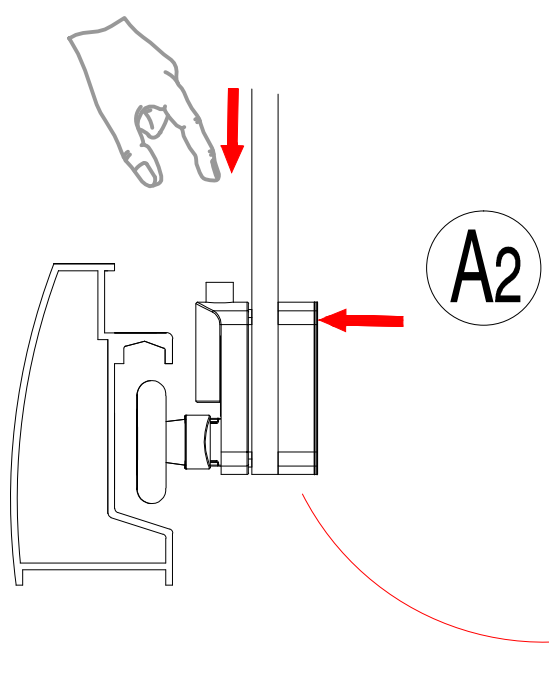
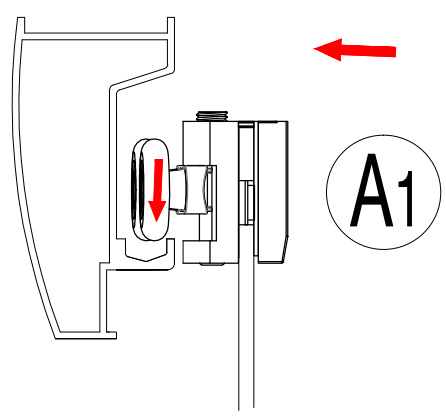
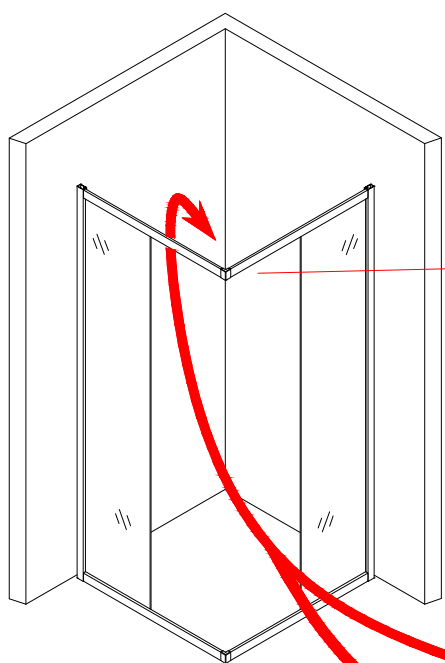

Justering av dørene gjøres enkelt på de øvre trinsehjulene.

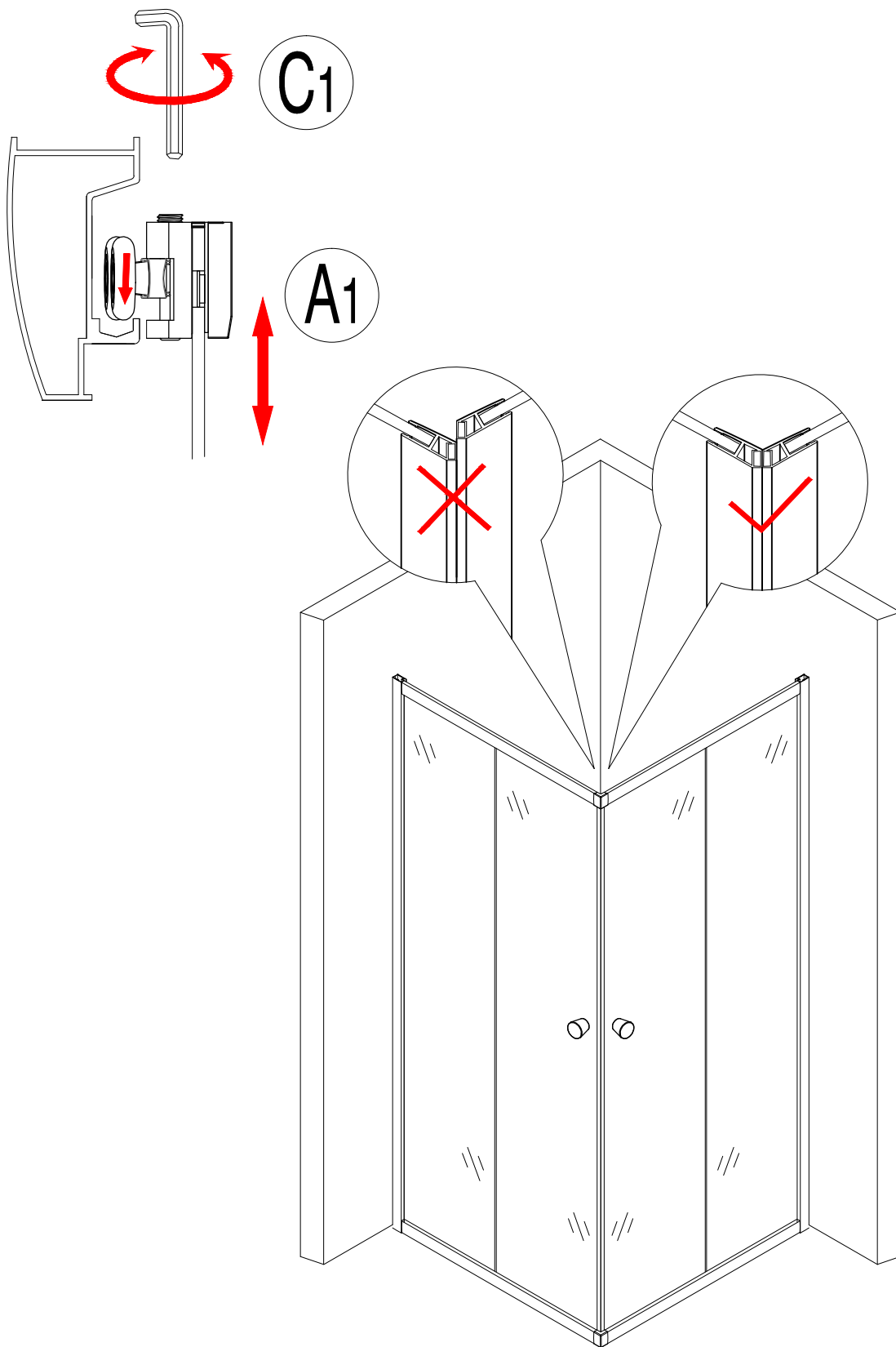

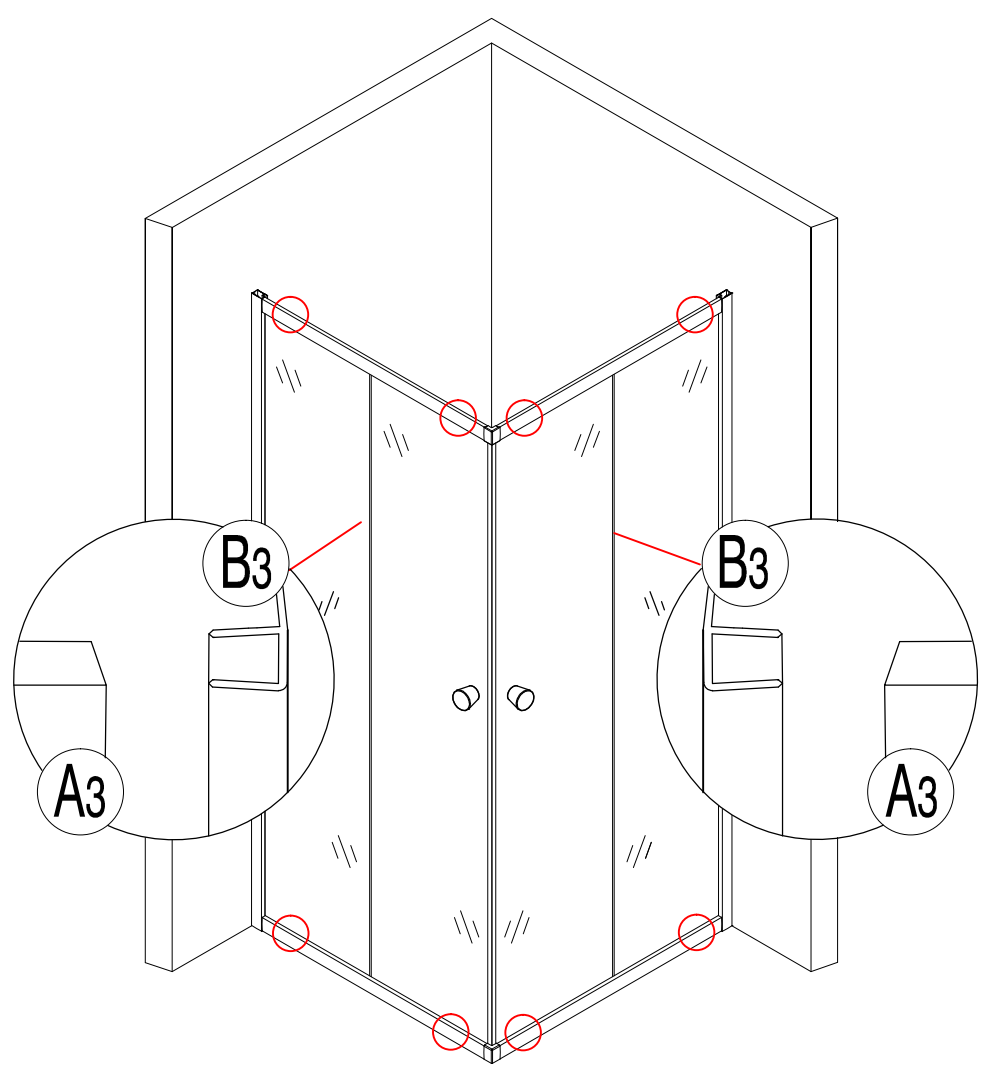
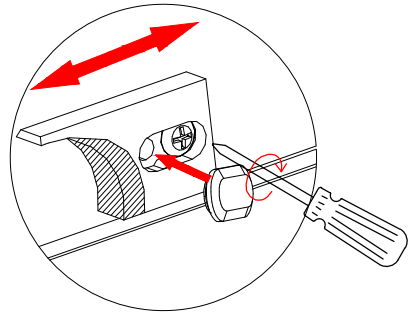

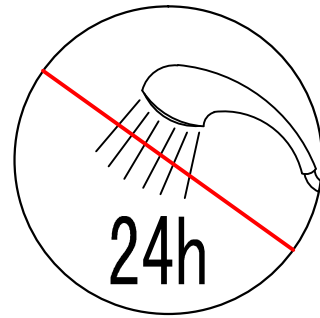
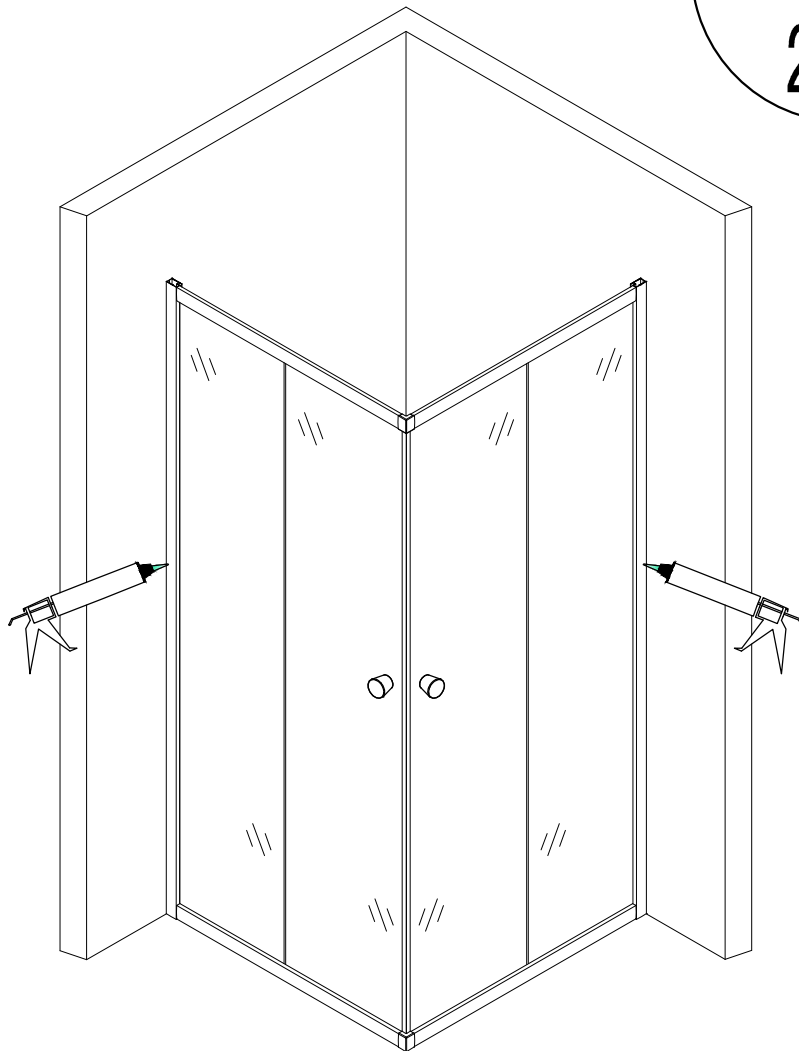

Silicon påføres på yttersiden av profilene. Bruk sanitærsilicon.

La siliconen få tørke før dusjen blir tatt i bruk.

Rengjøring av dusjen: (cleaning of shower)

Kalk og såperester vaskes lett bort med spraysåpen Sanicid eller annen rengjøringsmiddel for dusj.

Bruk aldri slipende rengjøringsmidler på dusjen.